

DURONIC

WET SEPARATOR PRODUCTION LINE



Stretching Wider and Faster

 YOUNGWON

CEO Greetings

Dear valued customers,

ST Youngwon is a specialist in manufacturing lithium-ion battery wet separator production lines. Through our state-of-the-art production lines boasting world-class production speeds and widths, we provide maximized your production efficiency and capability.

The biggest strength of our production lines is the capability of industry-leading wide-width and high-speed production. This enables obtaining superior quality, capacity as well as utmost price competitiveness simultaneously.

With our slogan "Stretching wider and faster", we will continue to pursue wider, faster innovations based on cooperation with customers.

We look forward to working with you on this journey of growth and innovation.

CEO Kwon, Soonsik

History

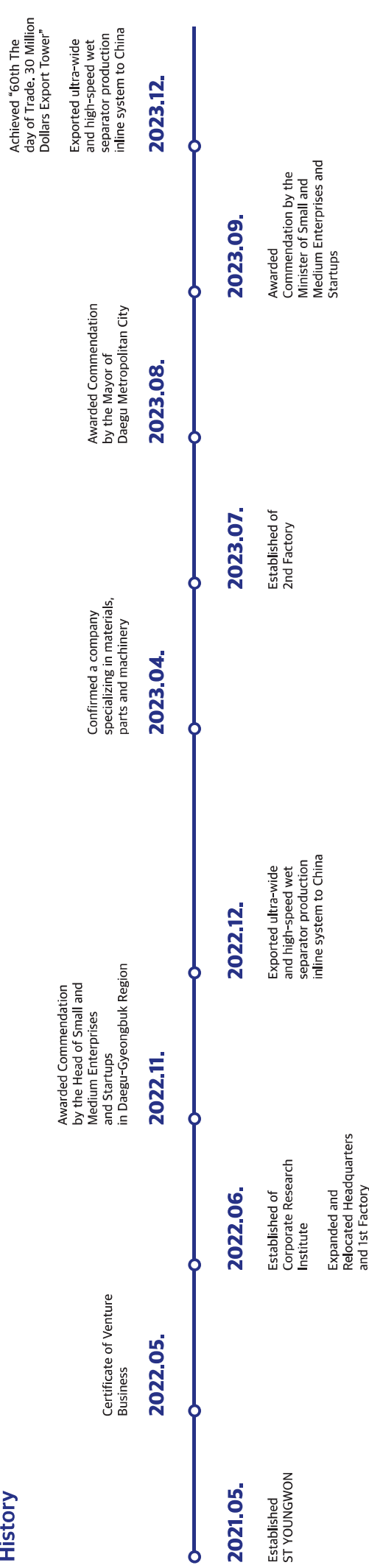

DURONIC 8300

TDO#2

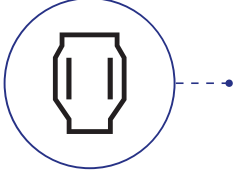

TDO#1



CASTING

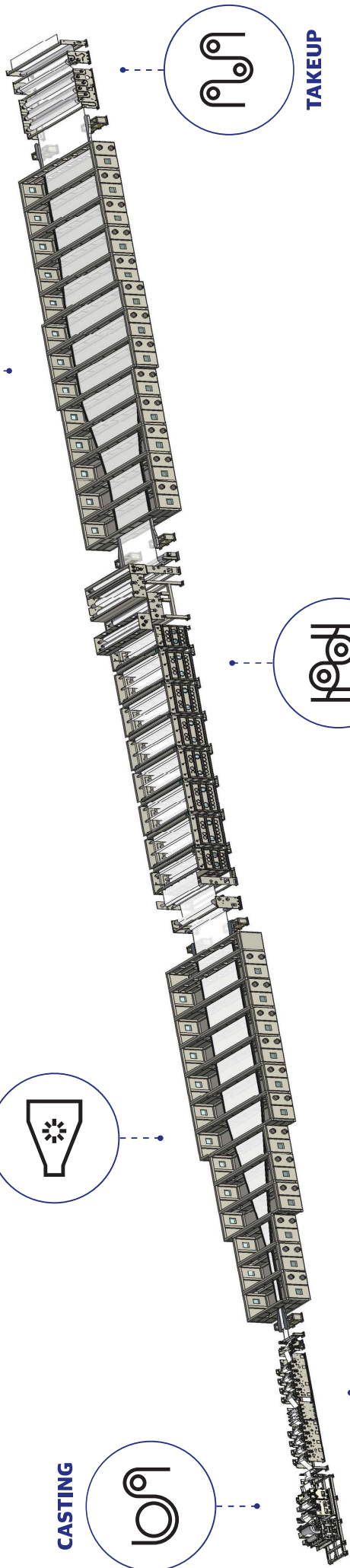

TAKEUP

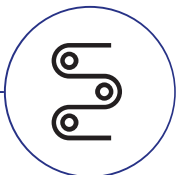

EXTRACTOR

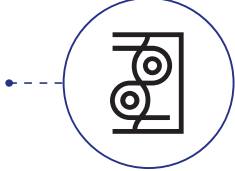

MDO

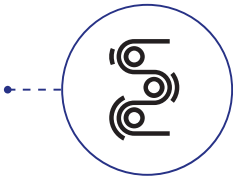

Super Wide

- TAKEUP width 8.3m
- Membrane width 8.0m

Super Fast

- Machine speed : ~120m/min
- Production speed : ~80m/min

Super Thin

- 5~15 μ m membrane
- Uniform thickness

Wet Process

- Uniform pores distribution

Full Inline Process

- Based on patents
- Total line length : 185m

Super Productivity

- Our Capacity : 300Mm²

Our First Product

Supply of DURONIC-8300 (2 lines) to a separator company in China



Team Building, Development

Feb. 2021 ~



First Contract

Mar. 2022



Installation

Feb. 2023 ~



Pilot Production

Jul. 2023 ~

Patents

5 registrations, 12 applications (domestic and international)



Clip opening and closing apparatus for film stretching



Nozzle apparatus and nozzle system for heat air supplying of film stretching equipment



Extracting solvent apparatus for manufacturing secondary battery separator



Air circulation system of TDO stretching equipment



Machine direction orientation of stretching apparatus for manufacturing secondary battery separator

Expanding into Asian, venturing into Global

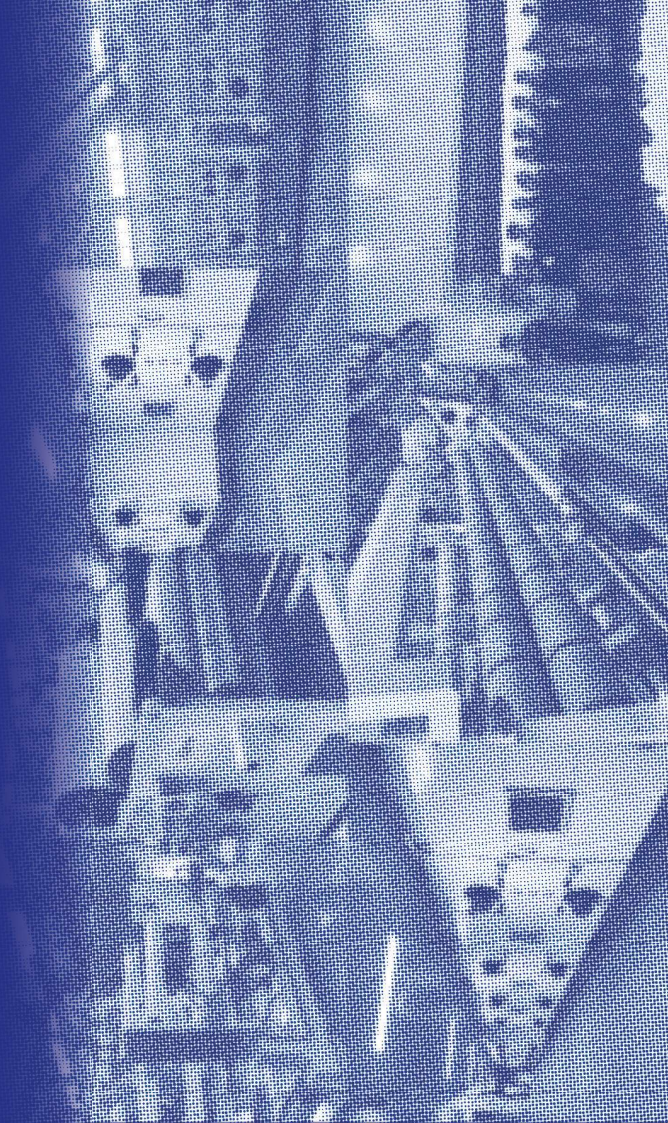
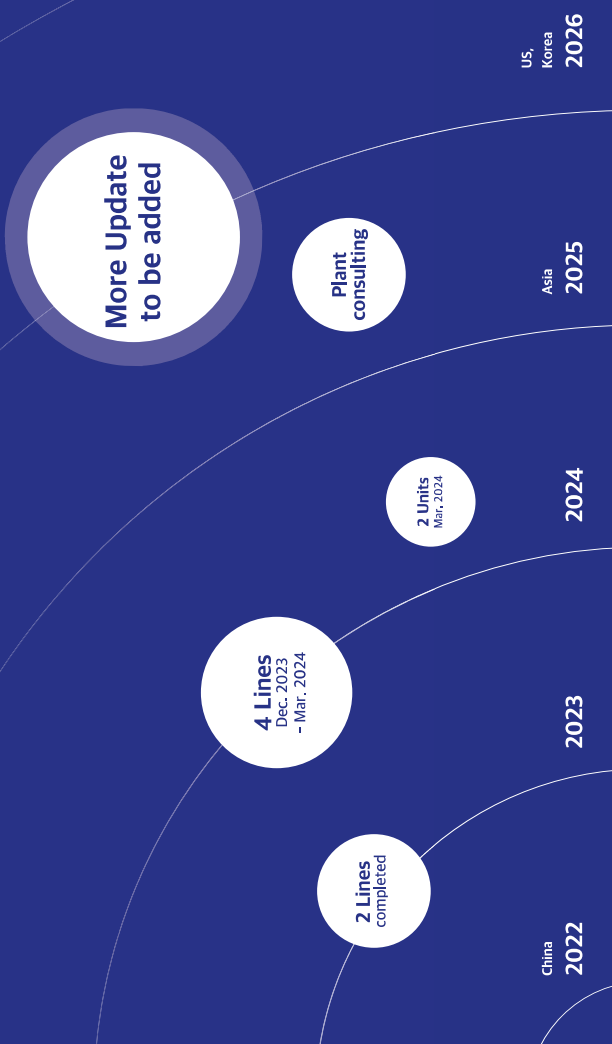

Stretching Wider and Faster



Headquarters | 1st Factory 85, Secheon-ro 3-gil, Dasa-eup, Dalseong-gun, Daegu, Republic of Korea
Waegwan Factory | 2nd Factory 32-11, Gongdan-ro 4-gil, Waegwan-eup, Chilgok-gun, Gyeongsangbuk-do, Republic of Korea

+82-53-716-0512 styoungwon@styoungwon.co.kr